

## GRAPHITE GASKET TYPE FULL FACE JIS B2220 - 5K

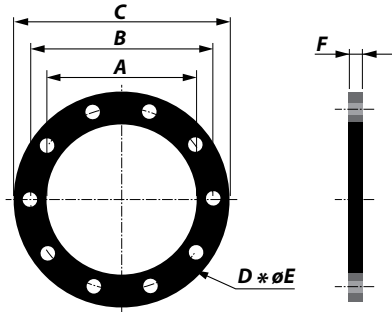

Article No.	Size (Inch)	NB (mm)	Pipe (mm)	A (mm)	B (mm)	C (mm)	D Number of holes	E Diameter of holes (mm)	F (mm)	Weight (kg)
213140020010	1	25	33.4	35	75	95	4	12	2	0.1
213140020013	1.25	32	42.2	43	90	115	4	15	2	0.1
213140020015	1.5	40	48.3	49	95	120	4	15	2	0.1
213140020020	2	50	60.3	61	105	130	4	15	2	0.1
213140020025	2.5	65	76.1	77	130	155	4	15	2	0.2
213140020030	3	80	88.9	90	145	180	4	19	2	0.2
213140020040	4	100	114.3	116	165	200	8	19	2	0.2
213140020050	5	125	139.7	142	200	235	8	19	2	0.2
213140020060	6	150	168.3	167	230	265	8	19	2	0.3
213140020080	8	200	219.1	218	280	320	8	23	2	0.3
213140020100	10	250	273.0	270	345	385	12	23	2	0.3
213140020120	12	300	323.9	321	390	430	12	23	2	0.3
213140020140	14	350	355.6	358	435	480	12	25	2	0.4
213140020160	16	400	406.4	409	495	540	16	25	2	0.4
213140020180	18	450	457.2	460	555	605	16	25	2	0.4
213140020200	20	500	508.0	511	605	655	20	25	2	0.5
213140020240	24	600	609.6	613	715	770	20	27	2	0.8
213140020280	28	700	711.2	715	820	875	24	27	2	0.8
213140020320	32	800	812.8	817	930	995	24	33	2	0.8
213140020360	36	900	914.4	919	1030	1095	24	33	2	1
213140020400	40	1000	1016.0	1021	1130	1195	28	33	2	1

### CHARACTERISTICS

**Gaskets** Hole pattern according type JIS Standard

**Material** Gaskets are produced out of graphite

**Range** Diameter range from 33.4 mm up to 1016 mm

**Thickness** 2 mm, with an option for 3 and 4 mm

**Temperature** The maximum allowable temperature is 600°C