

TYPE AC15

Compensators with rotatable flanges PN6

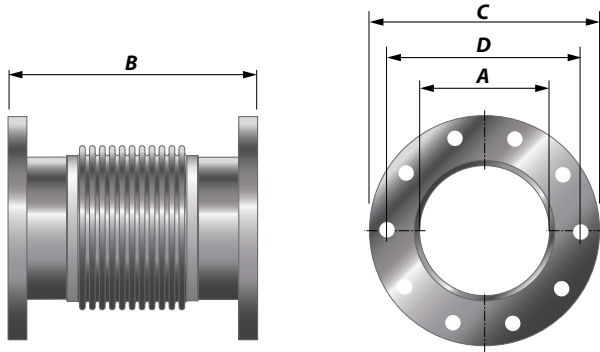

Article No.	A Size (Inch)	NB (mm)	Pipe (mm)	B Length (mm)	C O.D. (mm)	Flange		Movements*	
						Holes x d (mm)	D Bolt circle (mm)	Axial ± (mm)	Lateral ± (mm)
331405195015	1.5	40	48.3	195	130	4 x 14	100	35	18
331405195020	2	50	60.3	195	140	4 x 14	110	35	18
331405210025	2.5	65	76.1	210	160	4 x 14	130	38	16
331405250030	3	80	88.9	250	190	4 x 18	150	32	22
331405290040	4	100	114.3	290	210	4 x 18	170	32	28
331405305050	5	125	139.7	305	240	8 x 18	200	32	22
331405305060	6	150	168.3	305	265	8 x 18	225	32	20
331405310080	8	200	219.1	310	320	8 x 18	280	32	16
331405320100	10	250	273.0	320	375	12 x 18	335	40	17
331405320120	12	300	323.9	320	440	12 x 22	395	40	15
331405330140	14	350	355.6	330	490	12 x 22	445	40	14
331405340160	16	400	406.4	340	540	16 x 22	495	64	13
331405340180	18	450	457.2	340	595	16 x 22	550	64	11
331405340200	20	500	508.0	340	645	20 x 22	600	64	10
331405350240	24	600	609.6	350	755	20 x 26	705	64	9

*Movements (axial/lateral) are not in combination.



CHARACTERISTICS

- ✓ Carbon steel flanges according to DIN 2573 - PN6
- ✓ Stainless steel rotatable expansion joint AISI 321
- ✓ Max. pressure: 2.5 bar (20°C)
- ✓ Double Ply Bellows material
- ✓ Max. temperature: 550 °C
- ✓ All are stock items
- ✓ Standard length